

Information sheet

RoHS-compliant



CRR 1-80, CRR 1-80-T Low Power Current Transformer

IEC 61869-1, IEC 61869-6, IEC 61869-10

 Patents, utility models
and patent applications:

P.398526, P.398525,
 P.398508, P.396510, Ru64671,
 P.414745, P.410656,
 P.410323, P.410322, P.409870



The **CRR** current transformers are suited for installation in industrial environments on insulated cables or bushing insulators. Thanks to the possibility of disconnection, they can be applied to existing installations without having to dismantle those. They are used for measurements, energy quality analysis and protection in low-, medium- and high-voltage power networks with frequencies of 50 or 60 Hz.

The transformers are made in PCB (Printed Circuit Board) technology. As a result, very high precision of the transformer's geometry has been obtained and, consequently, high repeatability of electrical parameters. They are characterized by a constant conversion rate (sensitivity) over the entire measurement range. **CRR** current transformers developed at ITR work on the principle of Rogowski coil.

The conversion factor **S** is defined as the ratio of the RMS voltage value at the transformer output to the RMS value of the sinusoidal current at 50 Hz (60 Hz) flowing in the transformer's primary circuit. The conversion ratio **S** in a 60 Hz network is 1.2 times greater than in a 50 Hz network. This results from the fact that the voltage at the transformer output is proportional to the current derivative in the primary circuit.

Thanks to their very good electrical parameters, low weight and small size, the transformers replace classic core transformers. Transformers are offered in two versions, with thermocompensation (marked with the letter -T) and without thermocompensation, and in three accuracy classes: 0.5 / 0.2 / 0.1 defined for a temperature of 25°C.



An example view of current transformers from the CRR series



Observe national and sector-specific safety regulations during assembly and operation.

In the event of improper use or misuse of the transformer, the user bears full responsibility for the occurring safety hazard as well as the resulting damage.



Operating a damaged device may result in improper operation of the facility protected, which may lead to life or health hazards.

The correct and trouble-free operation of the device requires proper transport, storage, assembly, installation and commissioning, as well as correct operation, maintenance and servicing.

Assembly and operation of the device may only be carried out by appropriately trained personnel.



CRR current transformers are designed for monitoring and control in industrial facilities.

The **CRR** transformers can be connected and disconnected during operation without shorting the output terminals.

The terms **conversion ratio** and **sensitivity** used in the document are the same and determine the proportion of the current flowing in the primary circuit to the voltage value at the output of the secondary circuit.

We reserve the right to introduce changes in the device.

Installation method

The transformer connection should be made with a shielded twisted-pair cable. The twisted pair shield should be connected to the PE only from the side of the measuring or protection device (field controller).

The sequence of wires (S1, S2) in the twisted pair between the transformer connector and the field controller connector should be the same for all transformers, as shown in the picture

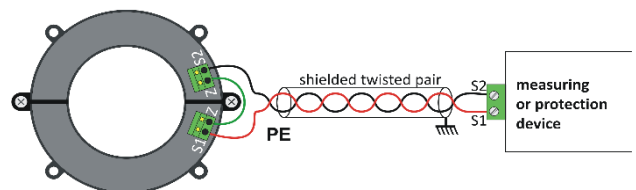

Connection diagram of the CRR transformer

The transformers should be fixed on the bushing or cable in the switchgear box permanently and without loose elements. They can be attached to a bracket using screws placed in the holes on the outer side of the housing, or to the cable using wedges or clamps.

During installation, the same positioning (installation direction) should be maintained for all transformers with respect to the current wires.

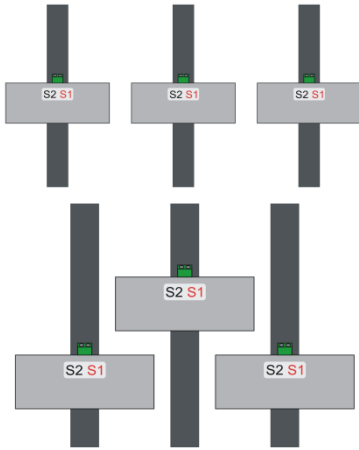

Correct mutual positioning of current transformers

The transformers can be offset from each other. None of the transformers can be inverted in relation to the others, as in the drawing showing incorrectly positioned transformers.

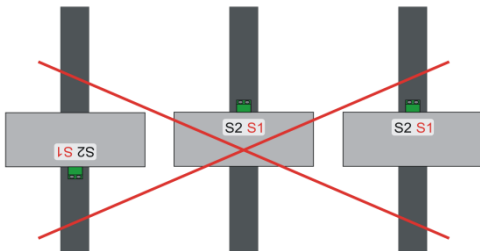

Incorrect mutual positioning of current transformers

The current cable or current bus does not have to be placed centrally in the transformer hole. The image shows acceptable ways to route the current cable through the transformer hole. The power cable should be placed in the hole as centrally as possible, but offsetting position in relation to the center is also acceptable and does not affect the quality of the transformer.

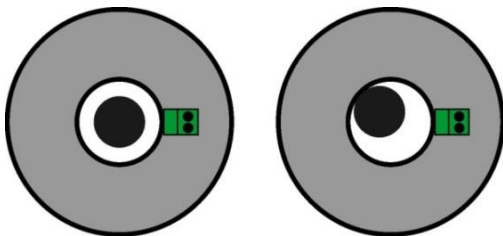

Correct, centric and eccentric positioning of the current cable

The current cable lead through the transformer hole cannot have a steel protective jacket. The screen should be repositioned back through the transformer hole as shown in the image. The screen output should be interlaced by the transformer in the direction opposite to the cable screen, so

that the magnetic fields generated by the current flowing in the screen cancel each other out.

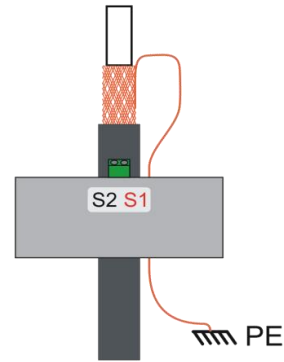

Installation method of the transformer on the shielded current cable.

The parameters required for the connecting cable, depending on its length, are specified in the table:

Transmission system for low power transformers	Long-term electric strength	Voltage impulse electric strength
Length of connecting cable <10 m	820 V	1,5 kV 1,2/50 μs
Length of connecting cable ≥ 10 m	3 kV	5 kV 1,2/50 μs



The recommended type of connecting cable that meets the above requirements - Belden 9501 or LIYCY 2x0,5.

Technical parameters

Input/output circuit

Maximum continuous voltage at the device terminals	~24 V
Maximum temporary voltage at the device terminals	~150 V
Maximum unique voltage at the device terminals	250 V
Test voltage of electrical strength	~2 kV
Rated frequency	50 / 60 Hz
Work frequencies	1 Hz ... 20 kHz
Accuracy class (3 versions)	0.5 0.2 0.1



The transformer's operating conditions (current, conversion factor) should be selected so that the transformer's output voltage does not exceed the safe voltage of ~ 24 V during normal operation

Environmental conditions

Working temperature	-40°C ... +80°C
Storage temperature	-55°C ... +90°C
Air humidity	no water vapor condensation and frost deposition
Insulation class after installation	1
Installation category	III
Class of industrial environment	B
Degree of contamination	2

Protection rating

Degree of housing protection	IP 68
Degree of protection - clamp joint	IP 40

Connectors

Clamp	SPTA1/2-3,5
Cable type (e.g. Belden 9501 or LIYCY 2x0,5)	shielded twisted pair 2 x 0.2...1.5mm ²

Mechanical resistance

Testing strength and resistance to sinusoidal vibrations	PN-EN 60255-21-1:1999	Class 1
Testing strength and resistance to single and multiple impacts	PN-EN 60255-21-2:2000	Class 1

Weight and dimensions

	CRR 1-80	CRR 1-80-T
Inner diameter [mm]	82	82
Outer diameter [mm]	126	126
Thickness [mm]	28	28
Weight [g]	280	280

Electrical parameters:

parameter	unit	conditions	CRR 1-80	CRR 1-80-T
S (Conversion Rate; load 2 MΩ / 50 pF, 25 °C)	[mV/A]	50 Hz	1,010	1,010
		60 Hz	1,212	1,212
Measurement range	[A]	min.	0.1	0.1
	[kA]	max.	24	24
Ith (1 s)	[kA]	≤1 s	150	150
Rc (rezystancja przekładnika)	[Ω]	-40°C	930	1520
		25°C	1240	1570
		80°C	1560	1590

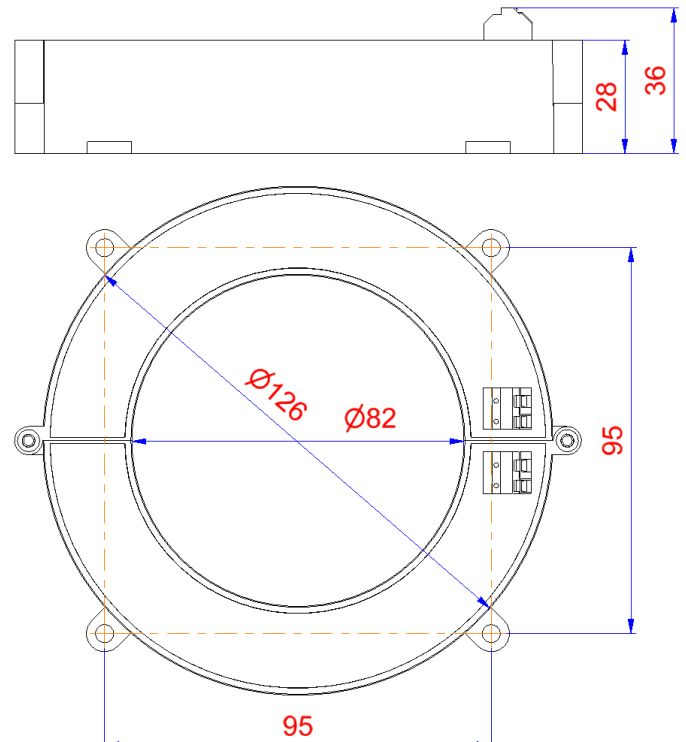
Housing

CRR 1-80, CRR 1-80-T housing

Calibration with the measuring system

The **Rc** transformer's own resistance together with the resistance of the input circuit of the **Ro** field controller creates a voltage divider. To obtain full accuracy of the measurement system, the conversion rate should be determined in the measuring system **Sp** according to the formula below.

$$S_p = S \frac{R_o}{R_o + R_c}$$

where:

- Sp** - conversion rate in the measurement system
- S** - conversion rate of an unloaded **CRR** current transformer
- Ro** - load resistance (input circuit resistance of the measuring system)
- Rc** - transformer's own resistance

Due to very high repeatability of transformer parameters, the calibration performed on one transformer can be duplicated for the rest when dealing with transformers and measuring devices of the same type and with similar cabling and operating conditions.

Characteristics

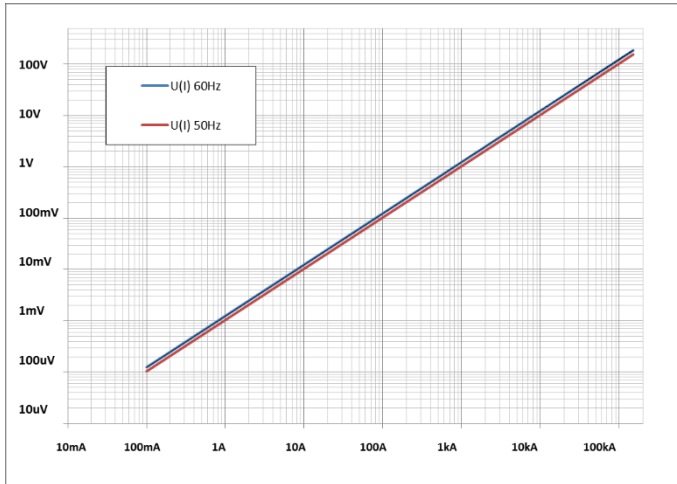

Characteristic of the U output voltage dependence on the current I

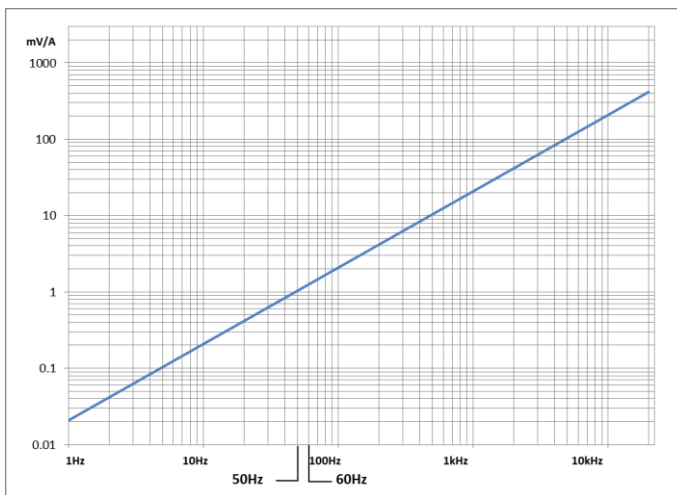

Characteristic of the dependence of the conversion rate S (sensitivity) on the frequency f of the current

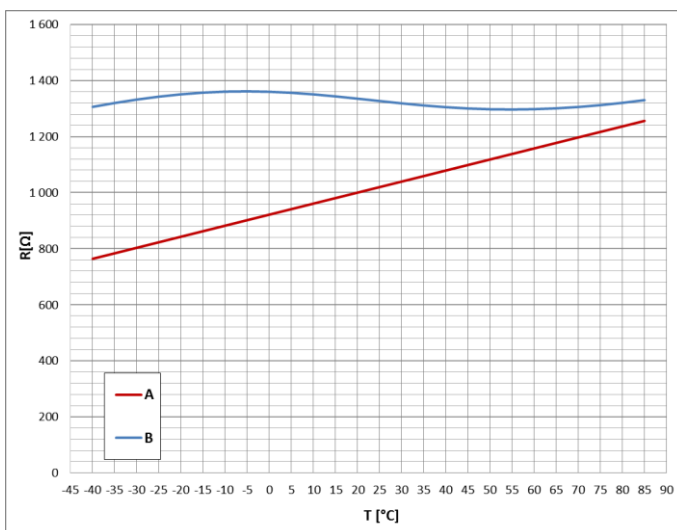

Characteristics of dependence of resistance on temperature (A - CRR 1-80, B - CRR 1-80-T)

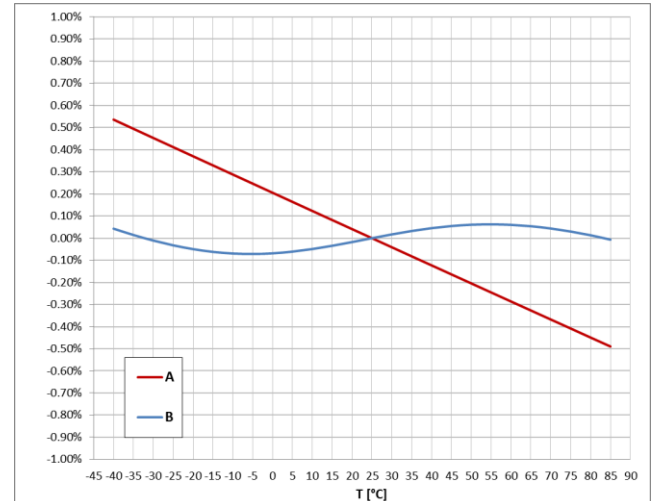

Characteristic of the dependence of the measurement error on temperature for $R_o=47k\Omega$ (A - CRR 1-80, B - CRR 1-80-T)

Order specification

Type	A	B
	CRR 1-80	
	CRR 1-80-T	
Class		
0.5		–
0.2		0.2
0.1		0.1

Order example

	Type		Class	
	A	B	A	B
	CRR 1-80			0.2

Current transformer with a conversion rate (sensitivity) of 1 mV/A; inner diameter 82 mm and 0.2 class.



If the accuracy class is not specified in the order, then class 0,5 is assumed.

If you need to make custom transformers, please contact us.

Warranty



The product is covered by a 36-month warranty. If the sale was preceded by an agreement signed by the Buyer, the provisions of this agreement shall apply.

The guarantee covers free removal of defects revealed during use, provided the conditions specified in the warranty sheet have been maintained. Detailed warranty conditions can be found on the website