



Capacitive voltage detecting system

---

## ***User manual***

Document version: 02i02  
Update: 2016-02-20



## Safety information

---



*When the device is in operation some of its parts may be connected to a hazardous live voltage.*



*Improper operation of the device or its application to purposes different from the intended use may pose hazards to operators and /or may lead to the equipment damage.*



*National and local electrical safety regulations must always be followed.*



*The user shall be held fully responsible for any safety risk and possible failures of the equipment that may arise due to such an improper operation or misuse.*



*Exploration of damaged device can result in malfunction of protected object and result in threat to life and health.*



*Reliable and defect-free operation of the device needs appropriate transportation, handling, storage, installation and commissioning as well as correct operation and maintenance.*



*The device can be installed and operated solely by accordingly trained personnel.*

## Attention

---



*We reserve the right to modify the device.*



*Device is an industrial monitoring and control instrument.*



*Remaining user documentation can be downloaded from [energetyka.itr.org.pl](http://energetyka.itr.org.pl)*

## Contents:

1.	Introduction .....	4
1.1.	Symbols .....	4
2.	General Information .....	4
2.1.	Destination of the equipment.....	4
2.2.	Features.....	5
2.3.	Front panel.....	5
2.4.	Optical signaling .....	5
3.	Operation manual.....	6
3.1.	Diagnostic .....	6
3.1.1.	DOC - Device operation check .....	6
4.	List of referred standards.....	7
5.	Technical parameters.....	7
5.1.	Input circuits .....	7
5.2.	Environmental conditions.....	7
5.3.	Construction .....	8
6.	Description of connectors .....	8
7.	Connection diagram.....	9
8.	Dimensions.....	9
9.	Remarks of manufacturer .....	10
9.1.	Maintenance, inspections, repairs .....	10
9.2.	Storage and transport.....	10
9.3.	Place of installation .....	10
9.4.	Disposal .....	10
9.5.	Warranty and service .....	11
10.	Order specification .....	11
11.	Contact.....	12

## 1. Introduction

### 1.1. Symbols



Electrical warning symbol indicates the presence of hazardous energy circuits or electric shock hazards.



The warning symbol indicates the important information related to the threat to life and health.



The information symbol indicates the clarification of relevant features and parameters of the device.

## 2. General information

### 2.1. Destination of the equipment



Device SN 2 is designed for a continuous voltage signalization in MV grids.



Fig. 2.1.1 The view of SN 2

SN 2 is provided with **TEST** for a local device operation check (DOC).



The voltage presence is indicated separately for every monitored phase by a displayed symbol . The device is made to the requirements of the **LRM** system - standard **IEC/PN-EN 61243-5**. Connection with current buses via reactance insulators.



*SN 2 is provided with a protection flap to block direct access to the front panel. During normal operation the protection flap should be closed. It shall be opened only for measurements; with measurements complete close the flap again.*

## 2.2. Features

### Diagnostic

- local device operation check mechanism (DOC)

### Case

- small dimensions 125.5 / 55,7 / 50 mm
- flush-mounted

### User interface

- 3 symbols signaling voltage presence on each monitored phase
-  for starting the DOC mechanism

### Signalization

Voltage presence at each of monitored phases - a lighted signal  on the LCD display:

## 2.3. Front panel

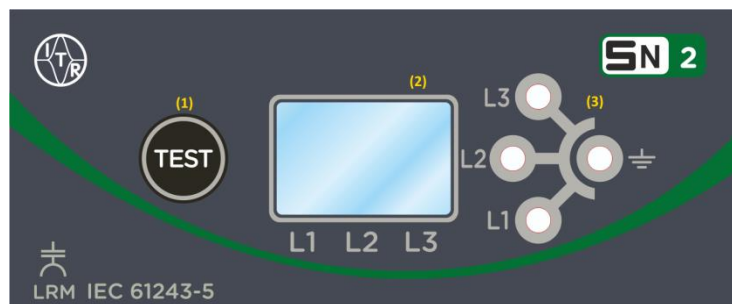



Fig. 2.3.1. Front panel view

On the front panel there are:

- 1) Touch key for starting the DOC mechanism
- 2) LCD display
- 3) LRM connector

## 2.4. Optical signaling

Tab. 2.4.1. Meaning of predefined diodes:

Symbol/Name	Color	Description
	black	signaling voltage presence on a given line



*In case of a strong solar radiation on the device front panel it might be necessary to manually dim the LCD display in order to make the signalization better readable.*

### 3. Operation manual











SN 2 is designed for continuous voltage signalization in MV grids. It checks three phase voltages and signals the presence of each of them.

On the LCD display a lighted symbol  means voltage presence on each monitored phase.



If after pressing **TEST** the optical signaling is not excited it means the device is damaged.

Tab. 3.1. Operation signaling:

LCD signaling			Phase voltage		
L1	L2	L3	L1	L2	L3
			•		
				•	
					•
			•	•	
			•	•	•
<b>TEST</b>			DOC mechanism started		
					

#### 3.1. Diagnostic

##### 3.1.1. DOC - Device operation check



Pressing the  causes the DOC - device operation mechanism to start. This operation consists in a short excitation of the LCD display. This allows to check the device operation during normal operation in MV grid regardless of the voltage presence on distribution busbars.



If after pressing **TEST** the optical signaling is not excited it means the device is damaged.

## 4. List of referred standards

The device described in this manual has been designed and is manufactured for industrial applications.

The engineering and manufacturing processes assume compliance with relevant standards. Adherence to these standards during installation, commissioning and operation of the device by the user is the essential precondition to achieve the desired performance and safety levels.

The device meets essential requirements specified in the applicable EU Directives:

- Electromagnetic compatibility (EMC) 2004/108/EC
- Low-voltage electrical equipment (LVD) 2006/95/EC

Tab. 4.1. Harmonized standards

No. of the standard	Title of the standard
PN-EN 61000-6-2:2008	Electromagnetic compatibility (EMC).
PN-EN 61010-1:2011	Safety requirements for electrical equipment for measurement, control, and laboratory use. General requirements.
PN-EN 61243-5:2004	Live working. Voltage detectors. Voltage detecting systems (VDS).
PN-EN 60529:2003	Specification for degrees of protection provided by enclosures (IP code).

## 5. Technical parameters

### 5.1. Input circuits

#### Voltage input circuits

Number of inputs	3
Minimal voltage threshold, LCD signaling	4 V rms
Input capacity	1500 pF + matching capacitor
Maximum length of the connected cables	< 3 m

### 5.2. Environmental conditions

Operational temperature	-25°C ... +55°C
Storage temperature	-35°C ... +85°C
Air humidity	lack of condensation and frost deposition
Equipment class	0
Overvoltage category	III
Electrical environment	B
Pollution degree	2
Mechanical tests	
Sinusoidal vibration	class 1
Single and multiple shocks and bumps	class 1
Seismic	class 0
Installation	indoor

### 5.3. Construction

Mass	< 0,2 kg
Dimensions (width, height, depth)	125.5 / 55,7 / 50 mm
<b>Degree of protection</b>	
Front panel side	IP 54
Connector side with connectors plugged	IP 30
<b>Connector</b>	
Type	Wago 254-454 not exposed to corrosion
Connection wires	Stranded cable 0,5...2 mm <sup>2</sup> (end sleeve) Solid cable 0,5...2.5 mm <sup>2</sup>
Stripping length	10 .. 12 mm
<b>Housing</b>	
mounting	flush-mounted

## 6. Description of connectors

Tab. 6.1. Connector X1

Terminal No.	Designation	Description / Purpose
1	L1	phase L1
2	L2	phase L2
3	L3	phase L3
4	PE	common for L1, L2, L3 (Earth PE)

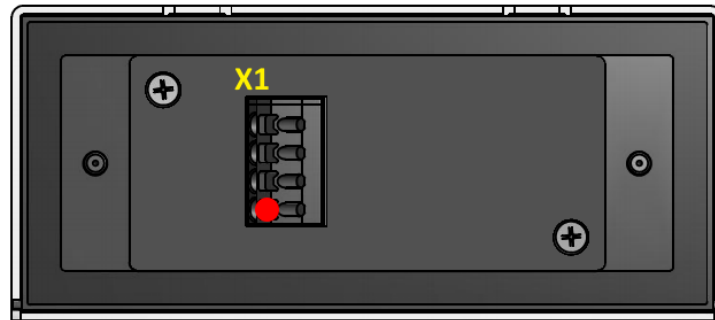

Fig. 6.1. The view of connectors side.



The red dot on the connector denotes the first pin of the terminal.



## 7. Connection diagram

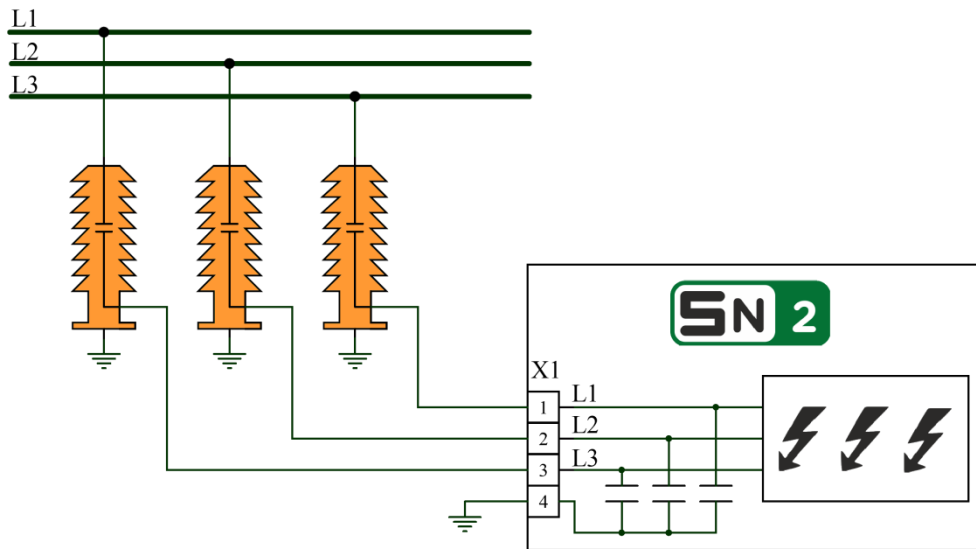

Fig. 7.1. Connection diagram

## 8. Dimensions

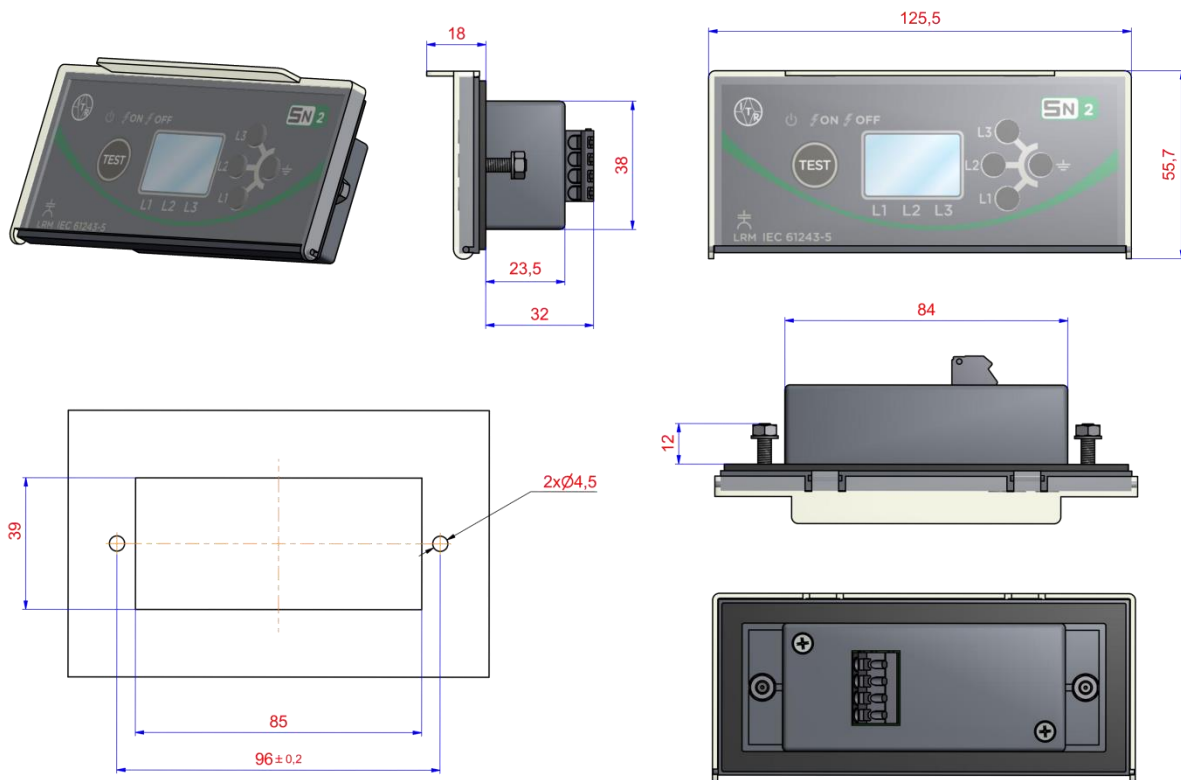

Fig. 8.1. Dimensions

## 9. Remarks of manufacturer

### 9.1. Maintenance, inspections, repairs



The manufacturer recommends that correctness of device operation is verified:

- a) each time - during commissioning,
- b) at least once a year - in mine face installations,
- c) at least once every 5 years in installations other than front face.

Also inspections resulting from branch regulations should be undertaken.

---

### 9.2. Storage and transport



Devices are packed in transport packages and secured against damage during transport and storage. Devices should be stored in transport packages, indoors, in places free from vibrations and direct effects of weather conditions, dry, well ventilated, free from harmful vapors and gases. Ambient air temperature should be between  $-35^{\circ}\text{C}$  and  $+85^{\circ}\text{C}$ , and relative humidity should not exceed 80%. All shipped devices are attached with user manual and warranty card.

---

### 9.3. Place of installation



SN 2 device is designed to installation in the mounting hole with dimensions of 85 mm x 35 mm at the door of the indoor power distribution bay. Length of single cable connected to device sockets cannot exceed 3 m.

Installation of the device:

- insert the device into the mounting hole
  - tighten the set screws to the surface of the door.
- 

### 9.4. Disposal



Devices are made mostly from recyclable materials, or materials that can be processed again or disposed of in environmentally sound manner. Decommissioned devices can be collected for recycling, provided that their condition is that of normal wear and tear. All components that are not recyclable shall be disposed of in environmentally sound manner.

---

## 9.5. Warranty and service



Regular 36-month guarantee period. Had the sale been preceded by execution of an Agreement between the Buyer and the Seller, provisions of such Agreement shall apply. Guarantee covers remedying of defects, free of charge, provided that instructions specified in the Warranty Card are adhered to. Detailed guarantee conditions may be found at [energetyka.itr.org.pl](http://energetyka.itr.org.pl) in the „Sale Regulations”.

- The guarantee period is counted from the date of sale.
- The warranty is extended by a period of residence of the product in the repair.
- Unauthorized tampering with the product will void the warranty.
- Warranty does not cover damage resulting from improper use of the product.

## 10. Order specification

SN 2	A
<b>Matching capacitor</b>	
lack	0
47 nF	1
100 nF	2
150 nF	3
4,7 nF	4
10 nF	5
22 nF	6
15 nF	7
6.8 nF	8

### Order example:

- SN 2: A1 - matching capacitor 47 nF
- SN 2: A2 - matching capacitor 100 nF



*In device of specification higher than A0 on the lines L1, L2, and L3 additional protective spark gaps SAL-90 are installed. At the customer's request they can be not installed.*



*Other versions after consultation with the manufacturer.*

## 11. Contact



---

### **Tele- and Radio Research Institute**

*ICT and Electronics Centre*

03-450 Warsaw, ul. Ratuszowa 11  
Poland

tel./fax: +48 22 590 73 91

e-mail: [energetyka@itr.org.pl](mailto:energetyka@itr.org.pl)

www: [energetyka.itr.org.pl](http://energetyka.itr.org.pl)

---